

Gróðurhúsaplast / Ylplast

Þykkt	Plötustærðir	Þyngd á plötu	Litur
6 mm	2100 x 6000 mm	16.38 kg	Glært
10 mm	2100 x 7000 mm	24.99 kg	Glært
10 mm	2100 x 7000 mm	24.99 kg	Opal hvítt
16 mm	2100 x 7000 mm	39.69 kg	Glært
16 mm	2100 x 7000 mm	39.69 kg	Opal hvítt
16 mm	980 x 3000 mm	7.94 kg	Opal hvítt
16 mm	980 x 3500 mm	9.26 kg	Opal hvítt
16 mm	980 x 4000 mm	10.58 kg	Opal hvítt

Glært

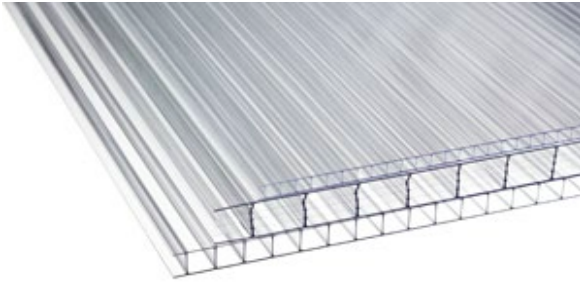

Opal hvítt



Fylgihlutir fyrir Gróðurhúsaplast / Ylplast

Vara

Öndunarteip
Álteip
Dropalisti
Stoppkanntur 50 mm
Tengilisti 60 mm
Gúmíborði í tengilista
Gúmí undirlisti 60 mm
Álvinkill 25 x 70 x 2,5 mm
Álskinna með þéttingu
Ylplast skrúfur

Efni

Strigi
Ál
Ál
Ál
Ál
Gúmí
Gúmí
Ál
Ál + neoprene
Galvaniserað járn



Báruplast

Stærð

1140 x 2500 mm

1140 x 3000 mm

1140 x 4000 mm

Klæðir

1020 mm

1020 mm

1020 mm

Þyngd á plötu

5.37 kg

6.44 kg

8.59 kg

Litur

Glær

Glær

Glær



Fylgihlutir fyrir báruplast

Vara

Báruskinna með þéttingu

Skrúfur



Efni

Ál + neoprene

Galvaniserað járn

Hugmyndir um frágang á ylplasti

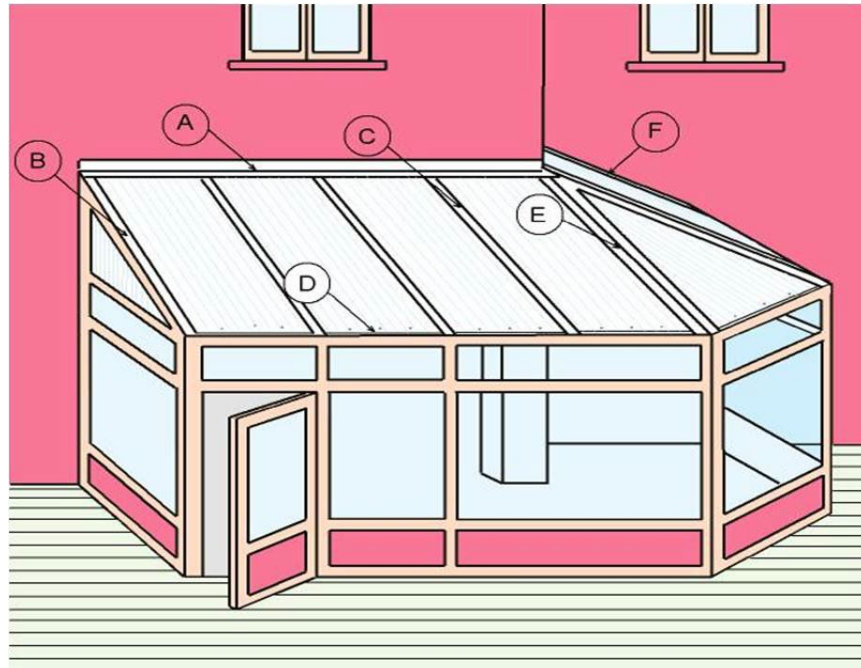

A

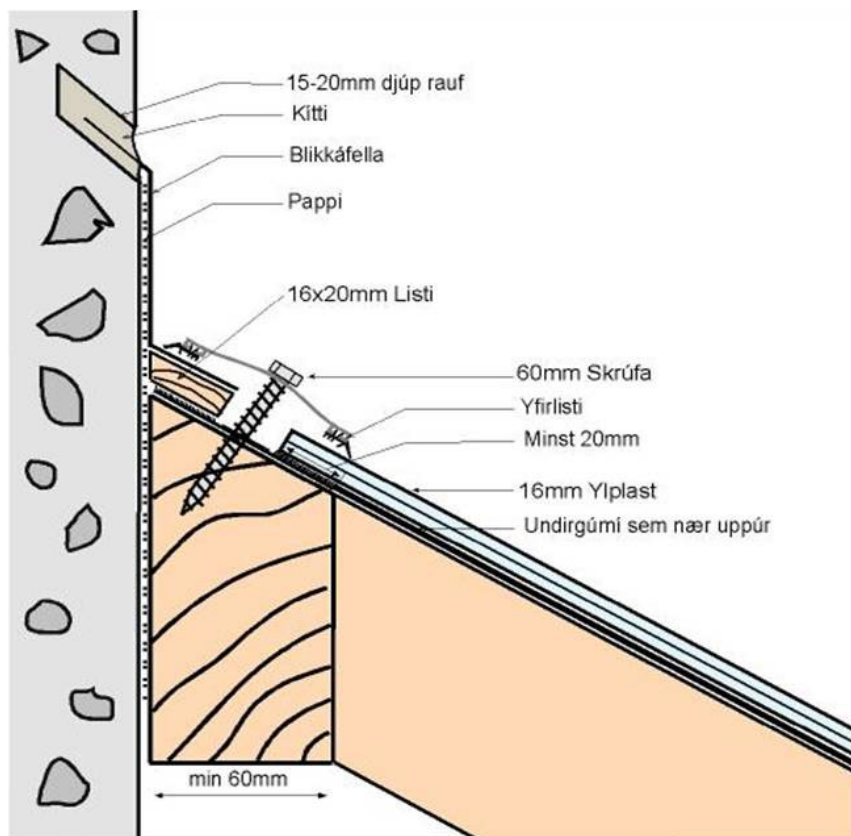

B

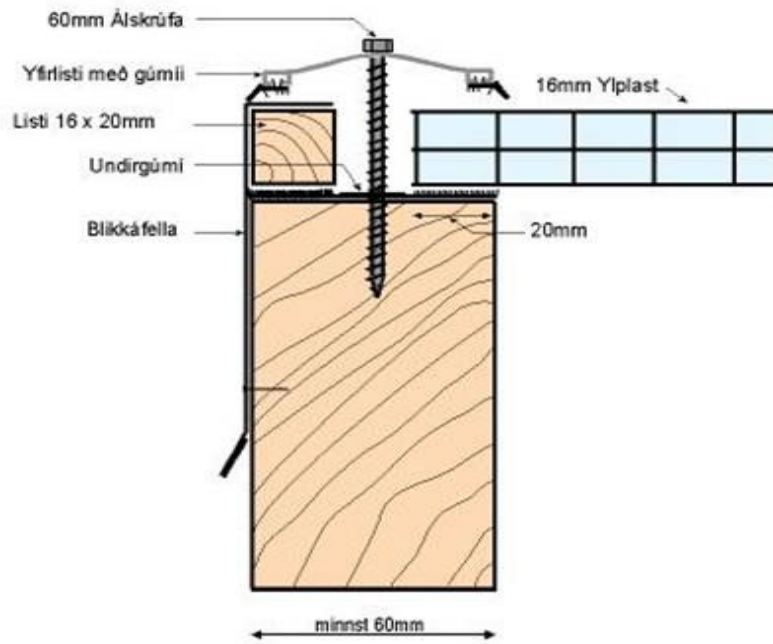

C

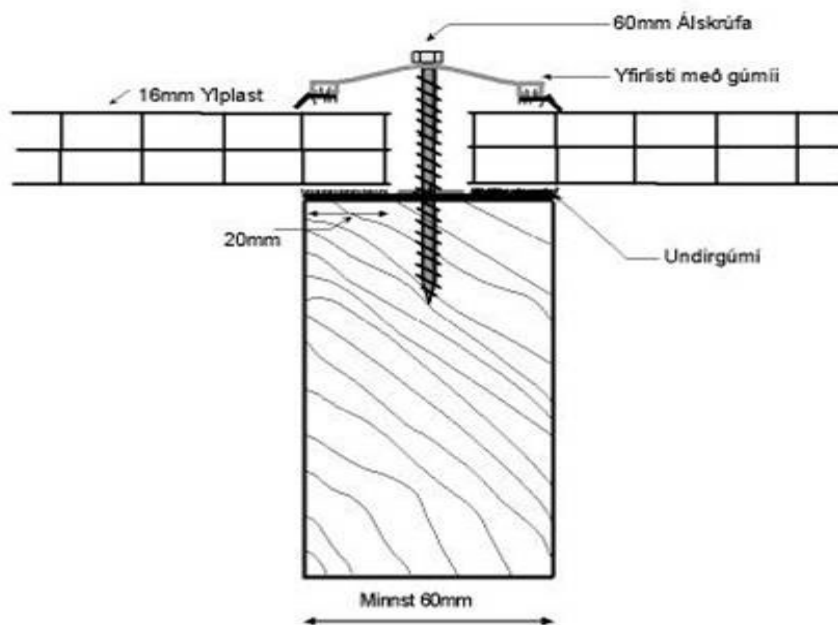

D

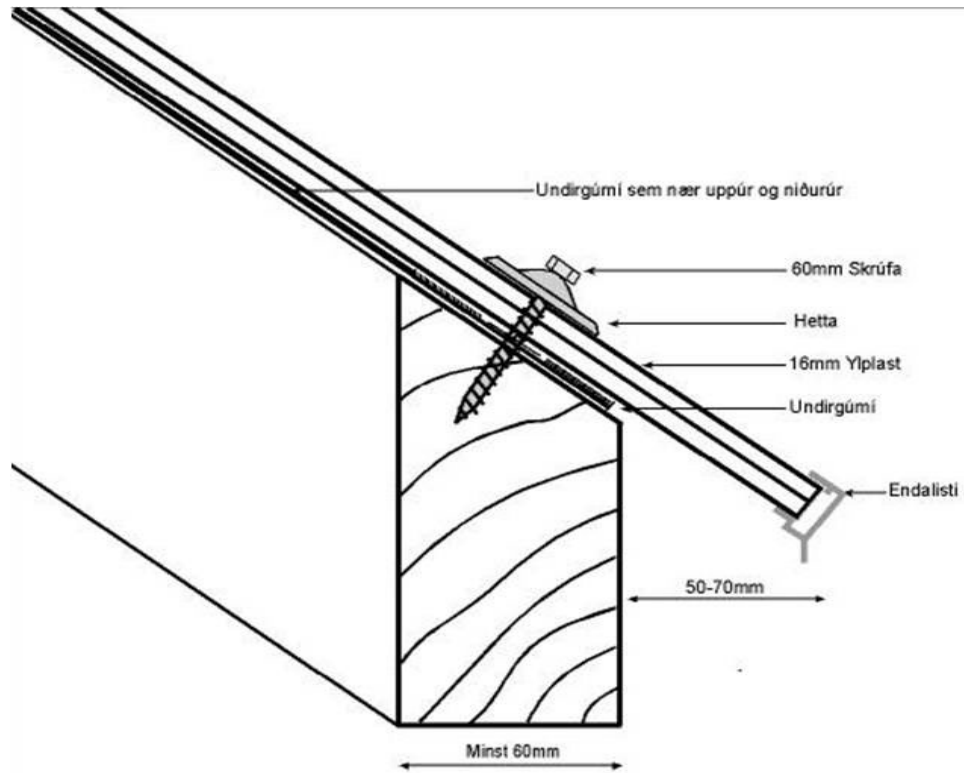

E

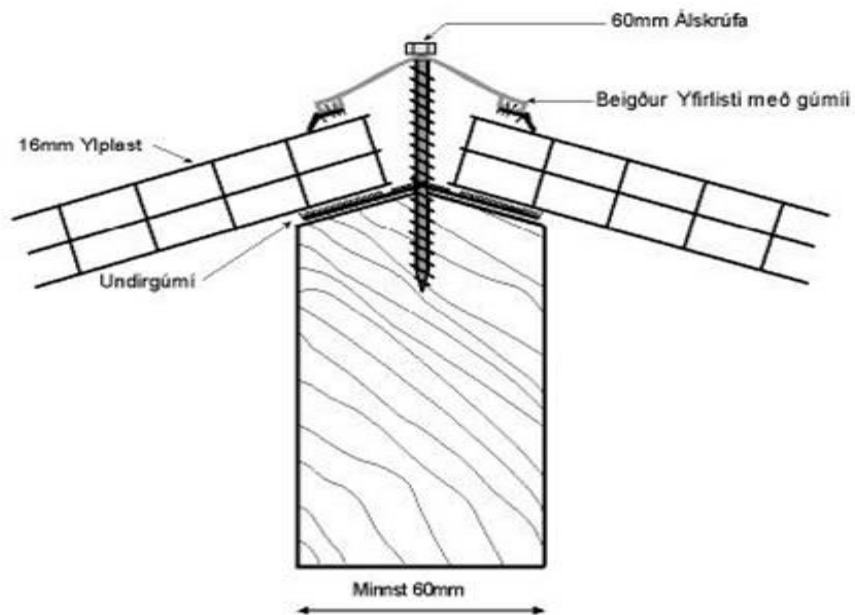

F

